

Reliable Basic Switches in a Wide Variation

- Wide variation of best-selling microswitches with switching currents of 10 to 21 A.
- Can be used for interrupting current when doors are opened or closed.
- Available in two types of cases: thermoplastic resin and thermosetting resin.

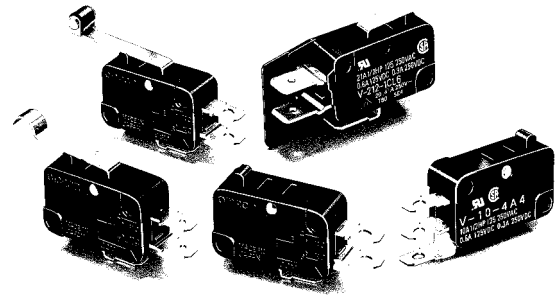

Ordering Information

■ Model Number Legend

V-□□□-□□□□-□
 1 2 3 4 5 6 7 8

1. Ratings

- 21: 21 A at 250 VAC
- 16: 16 A at 250 VAC
- 15: 15 A at 250 VAC
- 11: 11 A at 250 VAC
- 10: 10 A at 250 VAC

2. Contact Gap

- None: 1 mm (F gap)
- G: 0.5 mm (G gap) (for remodelling)

3. Actuator

- None: Pin plunger
- 1: Short hinge lever
- 2: Hinge lever
- 3: Long hinge lever
- 4: Simulated roller lever
- 5: Short hinge roller lever
- 6: Hinge roller lever

4. Contact Form

- 1: SPDT (COM bottom terminal, double-throw)
- 2: SPST-NC (COM bottom terminal, normally closed)
- 3: SPST-NO (COM bottom terminal, normally open)
- 4: SPDT (COM side terminal, double-throw)
- 5: SPST-NC (COM side terminal, normally closed)
- 6: SPST-NO (COM side terminal, normally open)

5. Terminals

- A: Solder terminals
- C2: Quick-connect terminals (#187)
- C: Quick-connect terminals (#250)
- B: Screw terminals

6. Barrier (Models with Thermoplastic Case Only)

- None: Without barrier
- R: Right-hand barrier
- L: Left-hand barrier

7. Maximum Operating Force

- 6: 3.92 N {400 gf}
- 5: 1.96 N {200 gf}
- 4: 0.98 N {100 gf}

Note: These values are for the pin plunger models.

8. Special Purpose (Models with Thermosetting Case Only)

- T: Heat-resistive

■ Available Combinations

Terminal				Thermoplastic case			Thermosetting case						
				Model	V-21	V-16	V-11	V-15		V-10			
					Rated current 21 A	16 A		11 A	15 A		10 A		
COM terminal position	Insulation barrier	Heat resistance	Terminal symbol	OF	3.92 N {400 gf}	3.92 N {400 gf}	1.96 N {200 gf}	0.98 N {100 gf}	3.92 N {400 gf}	1.96 N {200 gf}	1.96 N {200 gf}	0.98 N {100 gf}	
Bottom	No	Standard (80°C)	Solder terminals (A)	---	○	●	●	○	●	●	●	●	
			Quick-connect terminals (#187) (C2)	---	○	●	●	○	●	●	●	●	
			Quick-connect terminals (#250) (C)	●	○	●	●	○	○	○	○	○	○
			Screw terminals (B)	---	---	---	○ (1.96 N)	○	●	●	●	●	●
		Heat resistant (150°C)	Solder terminals (A)	---	---	---	---	○	●	●	●	●	●
			Quick-connect terminals (#187) (C2)	---	---	---	---	○	○	○	○	○	○
	Yes	Standard (80°C)	Solder terminals (A)	---	○	●	---	---	---	---	---	---	---
			Quick-connect terminals (#187) (C2)	---	○	●	---	---	---	---	---	---	---
			Quick-connect terminals (#250) (C)	●	○	●	---	---	---	---	---	---	---
			Solder terminals (A)	---	---	---	---	○	●	●	●	●	●
			Quick-connect terminals (#187) (C2)	---	---	---	---	○	○	○	○	○	○
			Quick-connect terminals (#250) (C)	○	---	---	---	---	---	---	---	---	---
Side	No	Standard (80°C)	Solder terminals (A)	---	---	---	---	○	●	●	●	●	
			Quick-connect terminals (#187) (C2)	---	---	---	---	○	○	○	○	○	
			Quick-connect terminals (#250) (C)	○	---	---	---	---	---	---	---	---	---

Note: 1. ●: Standard
○: Semi-standard







2. Consult your OMRON sales representative for specific models with standard approvals.

■ List of Models

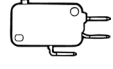
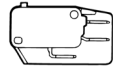
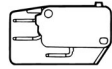





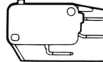
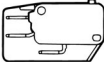

General-purpose Models

(Only combinations with standard terminals are shown.)







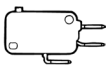

Thermoplastic Case

Actuator	COM terminal position	Contact form	Terminals (see note)	21 A (OF: 3.92 N {400 gf})		
				Without barrier	Right-hand barrier	Left-hand barrier
Pin plunger 	Bottom	SPDT	C			
				V-21-1C6	V-21-1CR6	V-21-1CL6
				V-21-2C6	V-21-2CR6	V-21-2CL6
Short hinge lever 		SPDT		V-21-3C6	V-21-3CR6	V-21-3CL6
				V-211-1C6	V-211-1CR6	V-211-1CL6
				V-212-1C6	V-212-1CR6	V-212-1CL6
Hinge lever 		V-213-1C6		V-213-1CR6	V-213-1CL6	
Long hinge lever 		V-214-1C6		V-214-1CR6	V-214-1CL6	
Simulated roller lever 		V-215-1C6		V-215-1CR6	V-215-1CL6	
Short hinge roller lever 	V-216-1C6	V-216-1CR6	V-216-1CL6			
Hinge roller lever 						

Note: C: Quick-connect terminals (#250)







Actuator	COM terminal position	Contact form	Terminals (see note)	16 A (OF: 1.96 N {200 gf})		
				Without barrier 	Right-hand barrier 	Left-hand barrier 
Pin plunger 	Bottom	SPDT	A	V-16-1A5	V-16-1AR5	V-16-1AL5
			C2	V-16-1C25	V-16-1C2R5	V-16-1C2L5
			C	V-16-1C5	---	---
		SPST-NC	A	V-16-2A5	V-16-2AR5	V-16-2AL5
			C2	V-16-2C25	V-16-2C2R5	V-16-2C2L5
			C	V-16-2C5	---	---
		SPST-NO	A	V-16-3A5	V-16-3AR5	V-16-3AL5
			C2	V-16-3C25	V-16-3C2R5	V-16-3C2L5
			C	V-16-3C5	---	---
Short hinge lever 	Bottom	SPDT	A	V-161-1A5	V-161-1AR5	V-161-1AL5
C2			V-161-1C25	V-161-1C2R5	V-161-1C2L5	
C			V-161-1C5	---	---	
Hinge lever 		A	V-162-1A5	V-162-1AR5	V-162-1AL5	
		C2	V-162-1C25	V-162-1C2R5	V-162-1C2L5	
		C	V-162-1C5	---	---	
Long hinge lever 		A	V-163-1A5	V-163-1AR5	V-163-1AL5	
		C2	V-163-1C25	V-163-1C2R5	V-163-1C2L5	
		C	V-163-1C5	---	---	
Simulated roller lever 		A	V-164-1A5	V-164-1AR5	V-164-1AL5	
		C2	V-164-1C25	V-164-1C2R5	V-164-1C2L5	
		C	V-164-1C5	---	---	
Short hinge roller lever 		A	V-165-1A5	V-165-1AR5	V-165-1AL5	
		C2	V-165-1C25	V-165-1C2R5	V-165-1C2L5	
		C	V-165-1C5	---	---	
Hinge roller lever 		A	V-166-1A5	V-166-1AR5	V-166-1AL5	
		C2	V-166-1C25	V-166-1C2R5	V-166-1C2L5	
		C	V-166-1C5	---	---	

Note: A: Solder terminals
 C2: Quick-connect terminals (#187)
 C: Quick-connect terminals (#250)

Actuator	COM terminal position	Contact form	Terminals (see note)	11 A (OF: 0.98 N {100 gf})
				Without barrier 
Pin plunger 	Bottom	SPDT	A	V-11-1A4
			C2	V-11-1C24
			C	V-11-1C4
Short hinge lever 			A	V-111-1A4
			C2	V-111-1C24
			C	V-111-1C4
Hinge lever 			A	V-112-1A4
			C2	V-112-1C24
			C	V-112-1C4
Long hinge lever 			A	V-113-1A4
			C2	V-113-1C24
			C	V-113-1C4
Simulated roller lever 			A	V-114-1A4
			C2	V-114-1C24
	C	V-114-1C4		
Short hinge roller lever 	A	V-115-1A4		
	C2	V-115-1C24		
	C	V-115-1C4		
Hinge roller lever 	A	V-116-1A4		
	C2	V-116-1C24		
	C	V-116-1C4		







Note: A: Solder terminals
C2: Quick-connect terminals (#187)
C: Quick-connect terminals (#250)

Thermosetting Case

Actuator	COM terminal position	Contact form	Terminals (see note 1)	15 A	10 A	
				OF: 1.96 N {200 gf}	OF: 1.96 N {200 gf}	OF: 0.98 N {100 gf}
Pin plunger 	Bottom	SPDT	A	V-15-1A5	V-10-1A5	V-10-1A4
			C2	V-15-1C25	V-10-1C25	V-10-1C24
			B	V-15-1B5	V-10-1B5	V-10-1B4
		SPST-NC	A	V-15-2A5	V-10-2A5	V-10-2A4
			C2	V-15-2C25	V-10-2C25	V-10-2C24
			B	V-15-2B5	V-10-2B5	V-10-2B4
		SPST-NO	A	V-15-3A5	V-10-3A5	V-10-3A4
			C2	V-15-3C25	V-10-3C25	V-10-3C24
			B	V-15-3B5	V-10-3B5	V-10-3B4
Side	SPDT	A	V-15-4A5	V-10-4A5	V-10-4A4	
		C2	V-15-5A5	V-10-5A5	V-10-5A4	
		B	V-15-6A5	V-10-6A5	V-10-6A4	
Short hinge lever 	Bottom	SPDT	A	V-151-1A5	V-101-1A5	V-101-1A4
			C2	V-151-1C25	V-101-1C25	V-101-1C24
			B	V-151-1B5	V-101-1B5	V-101-1B4
Hinge lever 			A	V-152-1A5	V-102-1A5	V-102-1A4
			C2	V-152-1C25	V-102-1C25	V-102-1C24
			B	V-152-1B5	V-102-1B5	V-102-1B4
Long hinge lever 			A	V-153-1A5	V-103-1A5	V-103-1A4
			C2	V-153-1C25	V-103-1C25	V-103-1C24
			B	V-153-1B5	V-103-1B5	V-103-1B4
Simulated roller lever 			A	V-154-1A5	V-104-1A5	V-104-1A4
			C2	V-154-1C25	V-104-1C25	V-104-1C24
			B	V-154-1B5	V-104-1B5	V-104-1B4
Short hinge roller lever 			A	V-155-1A5	V-105-1A5	V-105-1A4
			C2	V-155-1C25	V-105-1C25	V-105-1C24
			B	V-155-1B5	V-105-1B5	V-105-1B4
Hinge roller lever 			A	V-156-1A5	V-106-1A5	V-106-1A4
			C2	V-156-1C25	V-106-1C25	V-106-1C24
			B	V-156-1B5	V-106-1B5	V-106-1B4

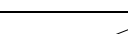
- Note:**
1. A: Solder terminals
 C2: Quick-connect terminals (#187)
 B: Screw terminals
 2. OF values shown in the table are for the pin plunger models.

Heat Resistant Models (Up to 150°C)

Actuator	COM terminal position	Contact form	Terminals	15 A	10 A
				OF: 1.96 N {200 gf}	OF: 0.98 N {100 gf}
Pin plunger 	Bottom	SPDT	Solder terminals (A)	V-15-1A5-T	V-10-1A4-T
Short hinge lever 				V-151-1A5-T	V-101-1A4-T
Hinge lever 				V-152-1A5-T	V-102-1A4-T
Long hinge lever 				V-153-1A5-T	V-103-1A4-T
Simulated roller lever 				V-154-1A5-T	V-104-1A4-T
Short hinge roller lever 				V-155-1A5-T	V-105-1A4-T
Hinge roller lever 				V-156-1A5-T	V-106-1A4-T

■ Barrier (V-21 and V-16 Models Only)

Right-hand Barrier

Left-hand Barrier

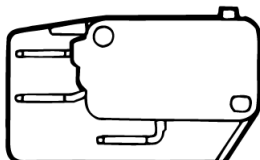
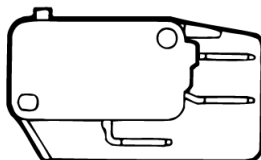

Specifications

■ Ratings

Model	Item	Resistive load
	Rated voltage	
V-21	250 VAC	21 A
	125 VDC	0.6 A
	250 VDC	0.3 A
V-16	250 VAC	16 A
	125 VDC	0.6 A
	250 VDC	0.3 A
V-15	250 VAC	15 A
	125 VDC	0.6 A
	250 VDC	0.3 A
V-11	250 VAC	11 A
	125 VDC	0.6 A
	250 VDC	0.3 A
V-10	250 VAC	10 A
	125 VDC	0.6 A
	250 VDC	0.3 A

Note: The ratings values apply under the following test conditions:

Ambient temperature: 20±2°C

Ambient humidity: 65±5%

Operating frequency: 30 operations/min

■ Switching Capacity per Load (Reference Values)

Model	Voltage	Non-inductive load				Inductive load			
		Resistive load		Lamp load		Inductive load		Motor load	
		NC	NO	NC	NO	NC	NO	NC	NO
V-21	250 VAC	21 A		3 A		12 A		4 A	
	8 VDC	21 A		5 A		12 A		7 A	
	30 VDC	14 A		5 A		12 A		5 A	
	125 VDC	0.6 A		0.1 A		0.6 A		0.1 A	
	250 VDC	0.3 A		0.05 A		0.3 A		0.05 A	
V-16	250 VAC	16 A		2 A		10 A		3 A	
	8 VDC	16 A		4 A		10 A		6 A	
	30 VDC	10 A		4 A		10 A		4 A	
	125 VDC	0.6 A		0.1 A		0.6 A		0.1 A	
	250 VDC	0.3 A		0.05 A		0.3 A		0.05 A	
V-15	250 VAC	15 A		2 A		10 A		3 A	
	8 VDC	15 A		4 A		10 A		6 A	
	30 VDC	10 A		4 A		10 A		4 A	
	125 VDC	0.6 A		0.1 A		0.6 A		0.1 A	
	250 VDC	0.3 A		0.05 A		0.3 A		0.05 A	
V-11	250 VAC	11 A		1.5 A		6 A		2 A	
	8 VDC	11 A		3 A		6 A		3 A	
	30 VDC	6 A		3 A		6 A		3 A	
	125 VDC	0.6 A		0.1 A		0.6 A		0.1 A	
	250 VDC	0.3 A		0.05 A		0.3 A		0.05 A	
V-10	250 VAC	10 A		1.5 A		6 A		2 A	
	8 VDC	10 A		3 A		6 A		3 A	
	30 VDC	6 A		3 A		6 A		3 A	
	125 VDC	0.6 A		0.1 A		0.6 A		0.1 A	
	250 VDC	0.3 A		0.05 A		0.3 A		0.05 A	

- Note:**
1. The above current values are the normal current values of models with a contact gap of 1 mm (gap F), which vary with the normal current values of models with a contact gap of 0.5 mm (gap G).
 2. Inductive load has a power factor of 0.4 min. (AC) and a time constant of 7 ms max. (DC).
 3. Lamp load has an inrush current of 10 times the steady-state current.
 4. Motor load has an inrush current of 6 times the steady-state current.

■ Characteristics

Operating speed	0.1 mm to 1 m/s (pin plunger models)
Operating frequency	Mechanical: 600 operations/min max. Electrical: 30 operations/min max.
Insulation resistance	100 MΩ min. (at 500 VDC)
Contact resistance (initial value)	15 mΩ max.
Dielectric strength (see note 2)	1,000 VAC, 50/60 Hz for 1 min between terminals of the same polarity V-21, V-16, and V-11 models: 2,000 VAC, 50/60 Hz for 1 min between current-carrying metal parts and ground, and between each terminal and non-current-carrying metal parts V-15 and V-10 models: 1,500 VAC, 50/60 Hz for 1 min between current-carrying metal parts and ground, and between each terminal and non-current-carrying metal parts
Vibration resistance (see note 3)	Malfunction: 10 to 55 Hz, 1.5-mm double amplitude
Shock resistance (see note 3)	Destruction: 1,000 m/s ² {approx. 100G} max. Malfunction: V-21/V-16/V-15: 300 m/s ² {approx. 30G} max. V-11/V-10: 200 m/s ² {approx. 20G} max.
Durability (see note 4)	Mechanical: 50,000,000 operations min. (60 operations/min) Electrical: V-21/V-16/V-15: 100,000 operations min. (30 operations/min) (V-15 heat resistive: 20,000 operation min. (30 operations/min)) V-11/V-10: 300,000 operations min. (30 operations/min) (V-10 heat resistive: 50,000 operation min. (30 operations/min))
Degree of protection	IEC IP40
Degree of protection against electric shock	Class I
Proof tracking index (PTI)	175
Ambient operating temperature	-25°C to 80°C (at ambient humidity of 60% max.) (with no icing) -25°C to 150°C for heat-resistive model (at ambient humidity of 60% max.) (with no icing)
Ambient operating humidity	85% max. (for 5°C to 35°C)
Weight	Approx. 6.2 g (pin plunger models)

- Note:**
1. The data given above are initial values.
 2. The dielectric strength values shown in the table are for models with a Separator.
 3. For the pin plunger models, the above values apply for use at both the free position and total travel position. For the lever models, they apply at the total travel position.
 4. For testing conditions, contact your OMRON sales representative.

■ Approved Standards

Consult your OMRON sales representative for specific models with standard approvals.

UL1054 (File No. E41515)/CSA C22.2 No. 55 (File NO. IR21642)

Rated voltage	V-21	V-16	V-15	V-11	V-10
125 VAC	21 A, 1/2 HP	16 A, 1/2 HP	15 A, 1/2 HP	11 A, 1/3 HP	10 A, 1/3 HP
250 VAC					
125 VDC	0.6 A	0.6 A	0.6 A	0.6 A	0.6 A
250 VDC	0.3 A	0.3 A	0.3 A	0.3 A	0.3 A

EN61058-01 (File No. 129608, VDE approval)

Rated voltage	V-21	V-16	V-11
250 VAC	20 (4) A	16 (4) A	11 (3) A

Testing conditions: 5E4 (50,000 operations), T105 (0°C to 105°C)

EN61058-1 (File No. T9451451, TÜV Rheinland approval)

Rated voltage	V-15	V-10
250 VAC	15 A	10 A
250 VDC	0.3 A	0.3 A

Testing conditions: 5E4 (50,000 operations), T85 (0°C to 85°C)

■ Contact Specifications

Item		V-21	V-16	V-15	V-11	V-10
Contact	Specification	Rivet				
	Material	Silver alloy			Silver	
	Gap (standard value)	1 mm (F gap) or 0.5 mm (G gap)				
Inrush current	NC	50 A max.	40 A max.	36 A max.	24 A max.	
	NO					
Minimum applicable load		160 mA at 5 VDC				

■ Contact Form

SPDT

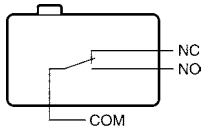

SPST-NC

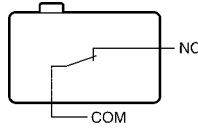

SPST-NO

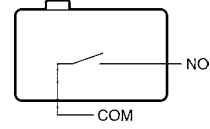

Engineering Data (Reference Values)

Mechanical Durability (Pin Plunger Models)

V-21/-16/-15/-10

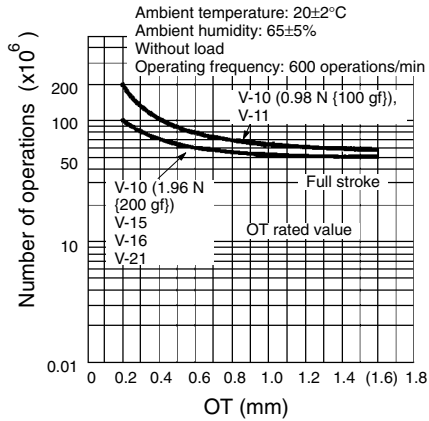

Electrical Durability (Pin Plunger Models)

V-21/-16/-15

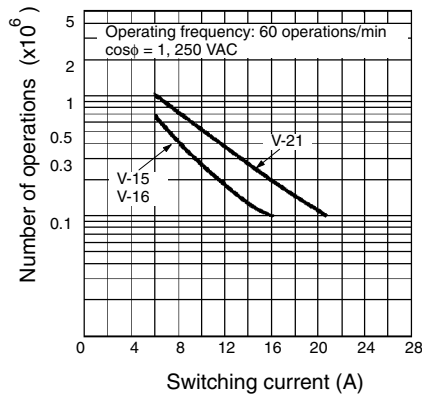

V-11/-10

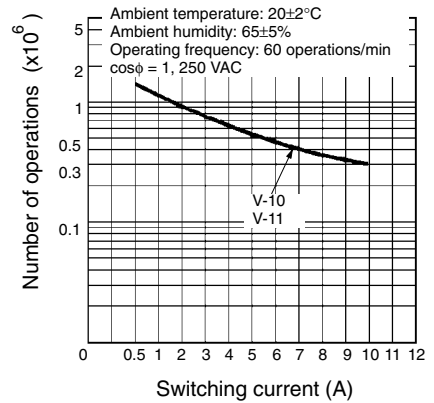

Dimensions

■ Terminals

- Note:**
- All units are in millimeters unless otherwise indicated.
 - The following is for the SPDT contact specifications. Two terminals will be available for SPST-NO or SPST-NC contact specifications. For terminal positions, refer to *Contact Form* on page 118.
 - Right-angle PCB terminal type is available
 D5 type: Pins at right angles, to the right.
 D6 type: Pins at right angles, to the left.
 Drawings will be provided if requested.

Terminal type	Solder terminals (A)	Quick-connect Terminals (#187) (C2)	Quick-connect Terminals (#250) (C)	Screw Terminals (B)
COM bottom position	<p>t = 0.5 Three, solder terminals</p>	<p>t = 0.5 Three, quick-connect terminals (#187)</p>	<p>t = 0.8 Three, quick-connect terminals (#250)</p>	<p>Three, #M3 x 0.5 x 3.2 Phillips screw washer t = 0.8 (7)</p>
COM side position				---
Terminal dimensions	<p>6.35 3.2 (see note) 4.75±0.1 2.4 dia. 1.6 dia. Note: Indicates the length to the center of the 1.6-dia. holes</p>	<p>6.35 3.2 4.75±0.1 1.6-dia. terminal hole</p>	<p>8.1 3.95 6.35±0.1 1.65-dia. terminal hole</p>	---

■ Mounting Holes

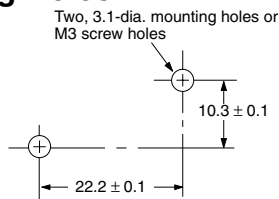

■ Dimensions and Operating Characteristics

Note: 1. All units are in millimeters unless otherwise indicated.

2. Unless otherwise specified, a tolerance of ± 0.4 mm applies to all dimensions.

3. The following illustrations and drawings are for quick-connect terminals (#250) (terminals C). V models with a switching current of 16 A or 11 A incorporates terminals A and C2. These models are different from #250 models in terminal size only. Terminals A, C2, and side common terminals are omitted from the following drawings. Refer to *Kinds of Terminals* on page 119 for these terminals.

4. The □ in the model number is for the terminal code.

5. The operating characteristics are for operation in the A direction (▼).

Pin Plunger Models

(Without Barrier)

V-21-1□6

V-16-1□5

V-11-1□4

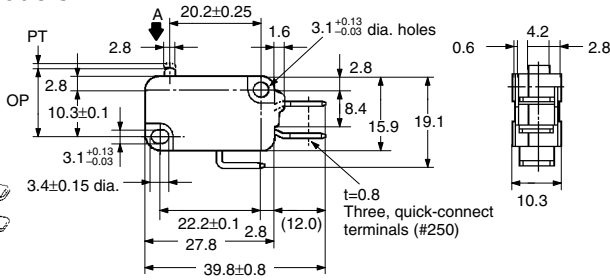
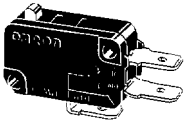

Model	V-21-1□6	V-16-1□5
OF max.	3.92 N {400 gf}	1.96 N {200 gf}
RF min.	0.78 N {80 gf}	0.49 N {50 gf}
PT max.	1.2 mm	
OT min.	1.0 mm	
MD max.	0.4 mm	
OP	14.7±0.4 mm	

(With Right-hand Barrier)

V-21-1□R6

V-16-1□R5

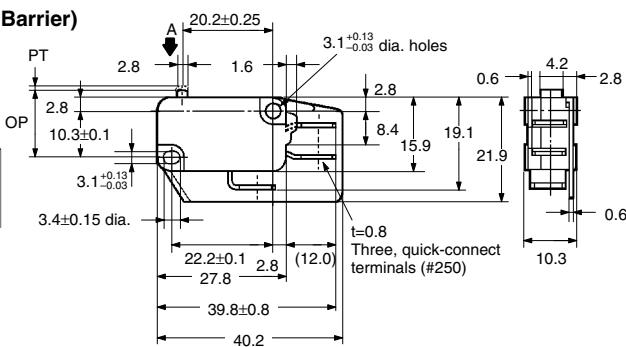
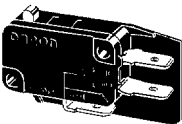

(With Left-hand Barrier)

V-21-1□L6

V-16-1□L5

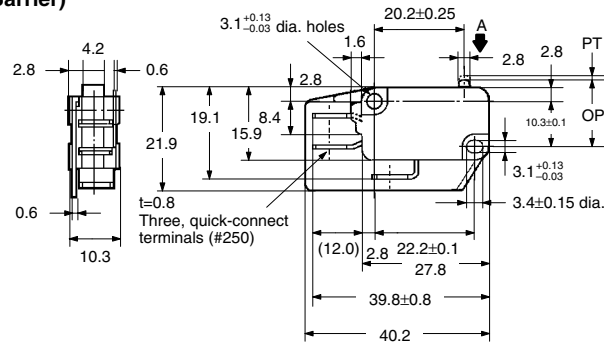

Model	V-11-1□4	V-11-1□5
OF max.	0.98 N {100 gf}	1.96 N {200 gf}
RF min.	0.20 N {20 gf}	0.49 N {50 gf}
PT max.	1.2 mm	
OT min.	1.0 mm	
MD max.	0.4 mm	
OP	14.7±0.4 mm	

Short Hinge Lever Models

- V-211-1□6
- V-161-1□5
- V-111-1□4

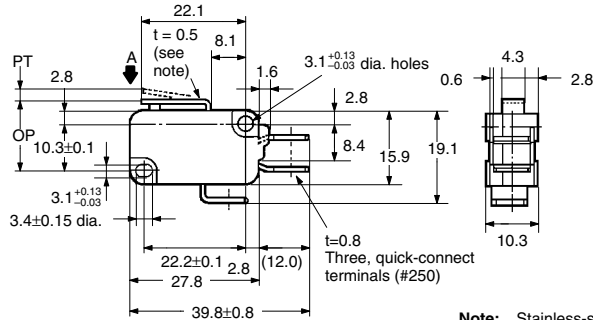
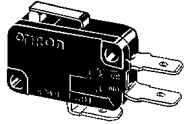

Model	V-211-1□6	V-161-1□5
OF max.	3.92 N {400 gf}	1.96 N {200 gf}
RF min.	0.49 N {50 gf}	0.49 N {50 gf}
PT max.	1.6 mm	
OT min.	0.8 mm	
MD max.	0.6 mm	
OP	15.2±0.5 mm	

Model	V-111-1□4
OF max.	0.98 N {100 gf}
RF min.	0.15 N {15 gf}
PT max.	1.6 mm
OT min.	0.8 mm
MD max.	0.6 mm
OP	15.2±0.5 mm

Hinge Lever Models

- V-212-1□6
- V-162-1□5
- V-112-1□4

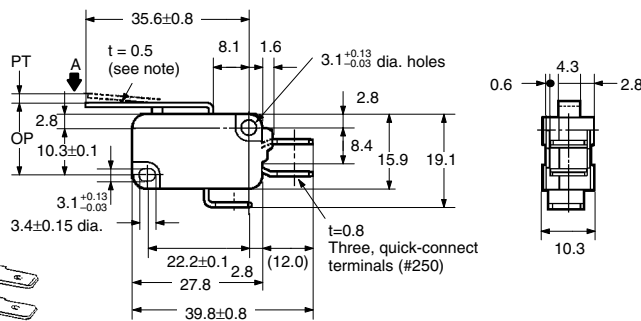
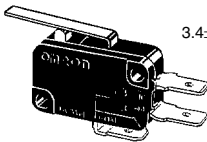

Model	V-212-1□6	V-162-1□5
OF max.	2.45 N {250 gf}	1.23 N {125 gf}
RF min.	0.25 N {25 gf}	0.14 N {14 gf}
PT max.	4.0 mm	
OT min.	1.6 mm	
MD max.	1.5 mm	
OP	15.2±1.2 mm	

Model	V-112-1□4
OF max.	0.59 N {60 gf}
RF min.	0.06 N {6 gf}
PT max.	4.0 mm
OT min.	1.6 mm
MD max.	1.5 mm
OP	15.2±1.2 mm

Long Hinge Lever Models

- V-213-1□6
- V-163-1□5
- V-113-1□4

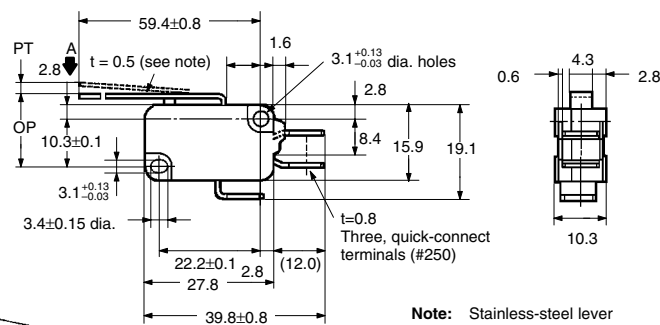
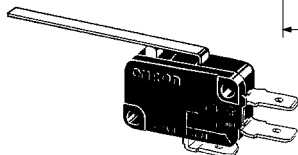

Model	V-213-1□6	V-163-1□5
OF max.	1.27 N {130 gf}	0.69 N {70 gf}
RF min.	0.12 N {12 gf}	0.06 N {6 gf}
PT max.	9.0 mm	
OT min.	2.0 mm	
MD max.	2.8 mm	
OP	15.2 ^{+2.6} / _{-3.2} mm	

Model	V-113-1□4
OF max.	0.34 N {35 gf}
RF min.	---
PT max.	9.0 mm
OT min.	3.2 mm
MD max.	2.8 mm
OP	15.2±2.6 mm

Simulated Roller Lever Models

V-214-1□6
V-164-1□5
V-114-1□4

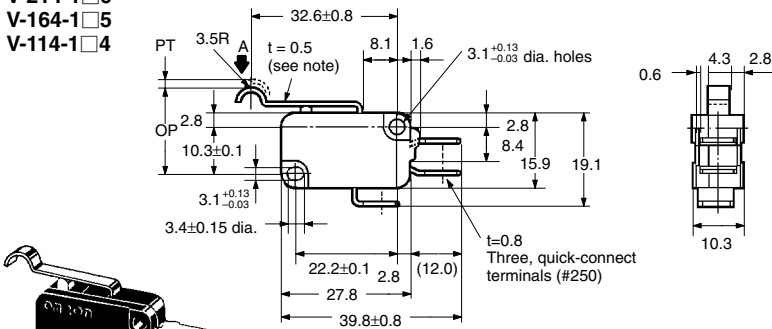

Note: Stainless-steel lever

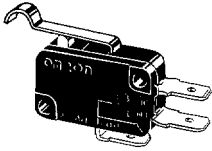

Model	V-214-1□6	V-164-1□5
OF max.	2.45 N {250 gf}	1.23 N {125 gf}
RF min.	0.25 N {25 gf}	0.14 N {14 gf}
PT max.	4.0 mm	
OT min.	1.6 mm	
MD max.	1.5 mm	
OP	18.7±1.2 mm	

Model	V-114-1□4
OF max.	0.59 N {60 gf}
RF min.	0.06 N {6 gf}
PT max.	4.0 mm
OT min.	1.6 mm
MD max.	1.5 mm
OP	18.7±1.2 mm

Short Hinge Roller Lever Models

V-215-1□6
V-165-1□5
V-115-1□4

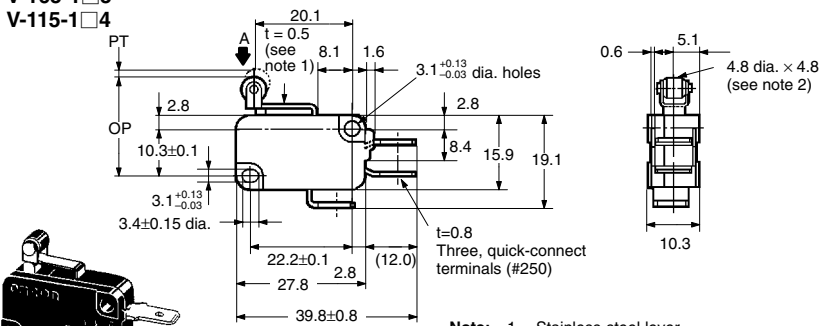

Note: 1. Stainless-steel lever
2. Oilless polyacetal resin roller

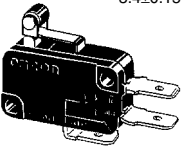

Model	V-215-1□6	V-165-1□5
OF max.	4.71 N {480 gf}	2.35 N {240 gf}
RF min.	0.49 N {50 gf}	0.49 N {50 gf}
PT max.	1.6 mm	
OT min.	0.8 mm	
MD max.	0.6 mm	
OP	20.7±0.6 mm	

Model	V-115-1□4
OF max.	1.18 N {120 gf}
RF min.	0.15 N {15 gf}
PT max.	1.6 mm
OT min.	0.8 mm
MD max.	0.6 mm
OP	20.7±0.6 mm

Hinge Roller Lever Models

V-216-1□6
V-166-1□5
V-116-1□4

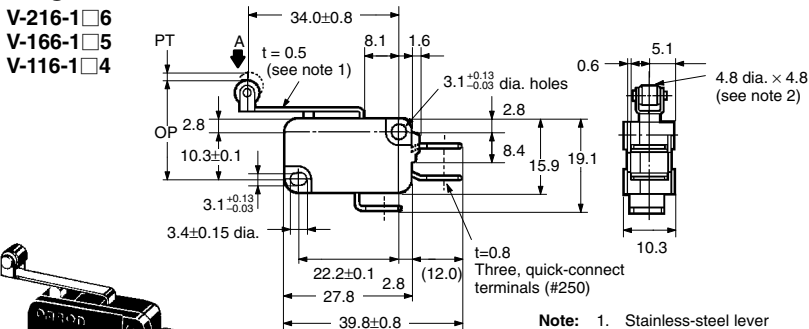

Note: 1. Stainless-steel lever
2. Oilless polyacetal resin roller

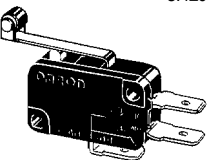

Model	V-216-1□6	V-166-1□5
OF max.	2.45 N {250 gf}	1.23 N {125 gf}
RF min.	0.25 N {25 gf}	0.14 N {14 gf}
PT max.	4.0 mm	
OT min.	1.6 mm	
MD max.	1.5 mm	
OP	20.7±1.2 mm	

Model	V-116-1□4
OF max.	0.59 N {60 gf}
RF min.	0.06 N {6 gf}
PT max.	4.0 mm
OT min.	1.6 mm
MD max.	1.5 mm
OP	20.7±1.2 mm

■ Thermosetting Case (V-15/-10 Models)

The following illustration and drawing are for solder and quick-connect terminals (#187) (terminals A). V models with a switching current of 15 A or 10 A incorporate terminals B or C2. These models are different from #187 models in terminal size only. Refer to *Terminals* on page 119 for these terminals.

Pin Plunger Models

- V-15-1□5
- V-10-1□5
- V-10-1□4

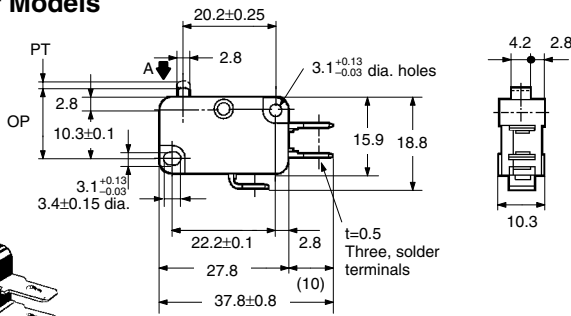
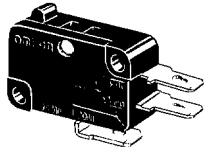

Model	V-15-1□5 V-10-1□5	V-10-1□4
OF max.	1.96 N {200 gf}	0.98 N {100 gf}
RF min.	0.49 N {50 gf}	0.20 N {20 gf}
PT max.	1.2 mm	
OT min.	1.0 mm	
MD max.	0.4 mm	
OP	14.7±0.4 mm	

Short Hinge Lever Models

- V-151-1□5
- V-101-1□5
- V-101-1□4

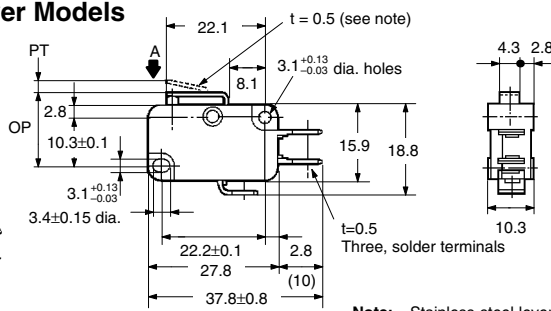
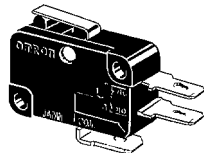

Note: Stainless-steel lever

Model	V-151-1□5 V-101-1□5	V-101-1□4
OF max.	1.96 N {200 gf}	0.98 N {100 gf}
RF min.	0.49 N {50 gf}	0.15 N {15 gf}
PT max.	1.6 mm	
OT min.	0.8 mm	
MD max.	0.6 mm	
OP	15.2±0.5 mm	

Hinge Lever Models

- V-152-1□5
- V-102-1□5
- V-102-1□4

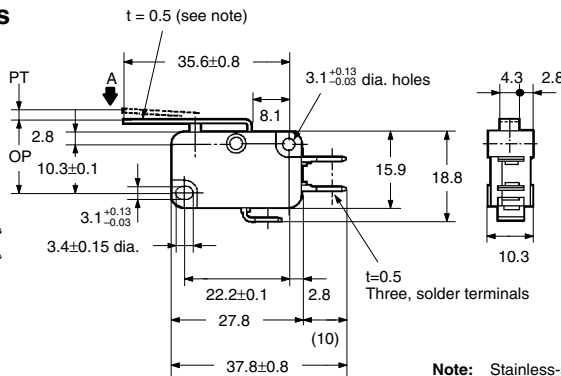
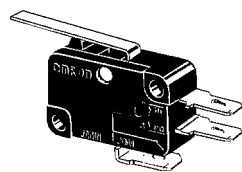

Note: Stainless-steel lever

Model	V-152-1□5 V-102-1□5	V-102-1□4
OF max.	1.23 N {125 gf}	0.59 N {60 gf}
RF min.	0.14 N {14 gf}	0.06 N {6 gf}
PT max.	4.0 mm	
OT min.	1.6 mm	
MD max.	1.5 mm	
OP	15.2±1.2 mm	

Long Hinge Lever Models

- V-153-1□5
- V-103-1□5
- V-103-1□4

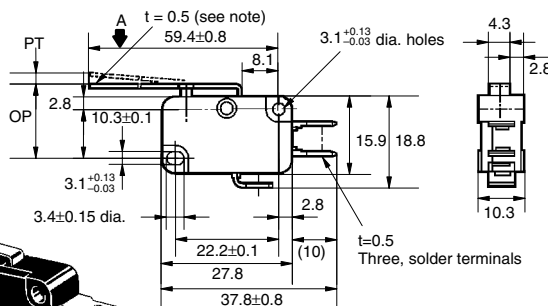
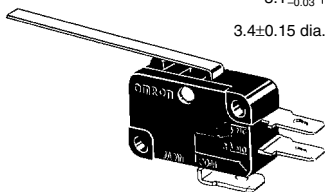

Note: Stainless-steel lever

Model	V-153-1□5 V-103-1□5	V-101-1□4
OF max.	0.69 N {70 gf}	0.34 N {35 gf}
RF min.	0.06 N {6 gf}	---
PT max.	9.0 mm	9.0 mm
OT min.	2.0 mm	3.2 mm
MD max.	2.8 mm	2.8 mm
OP	15.2 ^{+2.6} _{-3.2} mm	15.2±2.6 mm

Simulated Roller Lever Models

V-154-1□5
V-104-1□5
V-104-1□4

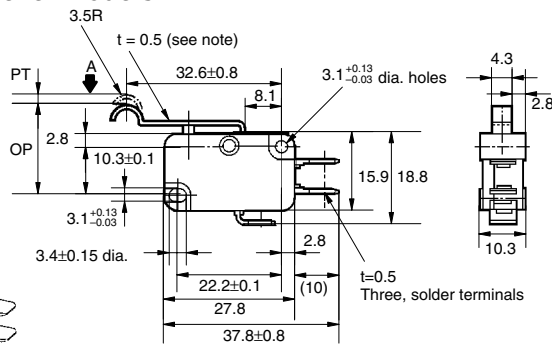
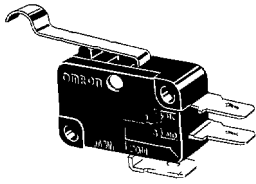

Note: Stainless-steel lever

Model	V-154-1□5 V-104-1□5	V-104-1□4
OF max.	1.23 N {125 gf}	0.59 N {60 gf}
RF min.	0.14 N {14 gf}	0.06 N {6 gf}
PT max.	4.0 mm	
OT min.	1.6 mm	
MD max.	1.5 mm	
OP	18.7 ± 1.2 mm	

Short Hinge Roller Lever Models

V-155-1□5
V-105-1□5
V-105-1□4

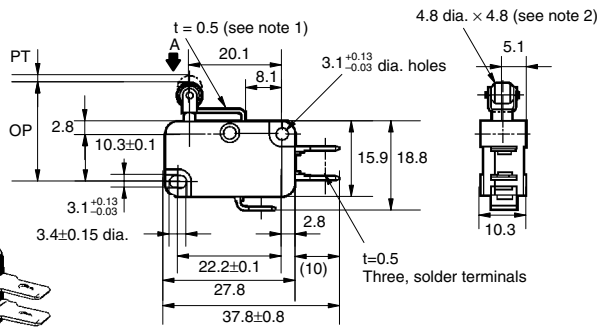
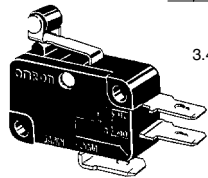

Note: 1. Stainless-steel lever
2. Oilless polyacetal resin roller

Model	V-155-1□5 V-105-1□5	V-105-1□4
OF max.	2.35 N {240 gf}	1.18 N {120 gf}
RF min.	0.49 N {50 gf}	0.15 N {15 gf}
PT max.	1.6 mm	
OT min.	0.8 mm	
MD max.	0.6 mm	
OP	20.7 ± 0.6 mm	

Hinge Roller Lever Models

V-156-1□5
V-106-1□5
V-106-1□4

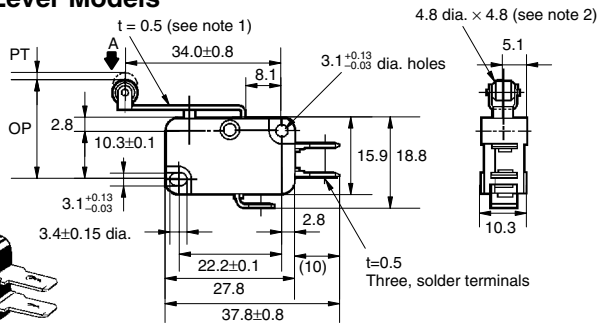
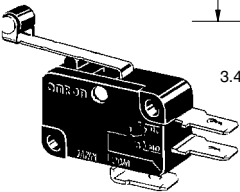

Note: 1. Stainless-steel lever
2. Oilless polyacetal resin roller

Model	V-156-1□5 V-106-1□5	V-106-1□4
OF max.	1.23 N {125 gf}	0.59 N {60 gf}
RF min.	0.14 N {14 gf}	0.06 N {6 gf}
PT max.	4.0 mm	
OT min.	1.6 mm	
MD max.	1.5 mm	
OP	20.7 ± 1.2 mm	

Precautions

Refer to pages 26 to 31 for common precautions.

■ Correct Use

Specifications Approved by TÜV Rheinland According to EN61058-1

Appropriate Cable Size (mm²)

Model	Solder terminals	Screw terminals
V-10	0.75, 1.25, 2.0	0.75, 1.25
V-15	1.25, 2.0	1.25

Use M3 crimp terminals for connecting to the screw terminals.

Applicable M3 crimp terminals:

Daido Solderless Terminal Mfg. Co., Ltd.	F1.25-3
J.S.T. Mfg. Co., Ltd.	1.25 B3A

Mounting

Use M3 mounting screws with plane washers or spring washers to securely mount the Switch. Tighten the screws to a torque of 0.39 to 0.59 N • m {4 to 6 kgf • cm}.

Insulation Distance

According to EN61058-1, the minimum insulation thickness for this Switch should be 1.1 mm and minimum clearance distance between the terminal and mounting plate should be 1.9 mm. If the insulation distance cannot be provided in the product incorporating the Switch, either use a Switch with insulation barrier or use a Separator to ensure sufficient insulation distance. Refer to Separator on page 152.

■ Actuator (Sold Separately)

Various Actuators are available as shown on pages 152 to 155.

■ Connector (Sold Separately)

Refer to Terminal Connectors on page 282.

ALL DIMENSIONS SHOWN ARE IN MILLIMETERS.

To convert millimeters into inches, multiply by 0.03937. To convert grams into ounces, multiply by 0.03527.